



ARBOURS
OF KESWICK

Design Guide

Arbours of Keswick Phase 1 Single Family & Streetscape Homes

Prepared for Rohit Land Development
by IBI Group

April 26, 2018



Table of Contents

1	Objectives	1
2	Architectural Theme	1
3	Streetscape	1
4	House Forms	1
5	House Size	2
6	Site Planning & Grading	3
7	House Repetition	3
8	Corner Lots	4
9	High Visibility Lots	4
10	Garages & Driveways	4
11	Exterior Colours	5
12	Roof Pitch & Materials	5
13	Front Entrances & Columns	6
14	Exterior Finishes & Other Design Details	7
15	Fencing + Landscape + Other	8
15.1	Fencing	8
15.2	Landscape.....	8
15.3	Address Plaque.....	9

Table of Contents (continued)

15.4	Accessory Buildings	10
15.5	Interpretation	10
16	Siting	11
16.1	Consultant	11
16.2	City Regulations	11
16.3	Grading	11
16.4	Plot Plans	11
17	Subdivision Appearance	11
17.1	Signage	11
17.2	Excavation Material	12
17.3	Clean-Up	12
17.4	Construction Activity	12
18	Approval Process	12
	Appendix “A” – Community Map	13
	Appendix “B” – Styles	14
	Appendix “C” – Approved Colour Selections	18
	Appendix “D” – Landscape Patio and Screen Requirements	20
	Appendix “E” – Fence Details	21
	Appendix “F” – Address Plaque	22

1 Objectives

The objective of this design guide is to create a sophisticated and elegant design statement for the single family and streetscape homes of Phase 1 while ensuring compatibility among homes by integrating the use of simple modern forms and highest standard of natural landscape. Outlining the opportunities and constraints of building, this design guide will assist builders, designers and home buyers in achieving problem-free construction. The Phase 1 map is presented in Appendix 'A'. Any variation to these Guidelines will be at the sole discretion of the Designated Design Consultant.

2 Architectural Theme

The selected architectural theme provides elements that can be incorporated within the following styles:

- Prairie Modern;
- Modern Classic;
- Heritage Modern.

These architectural elements include enclosed entries, carefully detailed brick or stonework and substantial detailing that highlights the design style. These elements work together to achieve an interesting and appealing streetscape.

3 Streetscape

Care must be taken to integrate the home with special attention to the relationship with neighbouring properties. Relative massing, siting and style will be of utmost importance in assuring each home compliments its neighbour and the surrounding development. Building massing, siting and style may be adjusted and/or alternate treatments requested to reinforce the streetscape. Entranceways are to cover and protect the space, at the first level or a height proportionate to the design. The style, width, height and detailing of entranceways will together create a sense of arrival, as well as help to articulate the design style of each home.

4 House Forms

Homes are to be designed to coordinate with the size of the home, as well as the adjacent homes. In order to maintain a consistent streetscape, houses are not permitted to contain more than three (3) wall variations (planes) on the second floor.

For streetscape homes, a maximum recess of 4' over the second floor over the garage wall plane is permitted, subject to design details. All home designs will require that the bottom of the front stairs is to have a maximum 2' offset from the garage front wall plane. If a home contains a full verandah then the front door is not to exceed 8' from the garage front wall plane.

Single family RSL homes are required to have a second floor minimum recess of 2' from garage front wall plane.

Homes that do not meet the setback/recess requirements as stated above may be considered at the discretion of the Designated Design Consultant. Homes will be reviewed on their individual merits of design and massing in relation to the streetscape.

5 House Size

Houses are to have a consistency of mass and volume within the streetscape. As such, house widths and sizes must relate proportionately and logically to the lot width and neighbouring houses.

The second floor area should be carefully designed. Minimum exposed house frontage will be established based on the pocket size of the lot as per the table below. A maximum 2' pocket relaxation will be permitted.

House Size & Pocket Fill (**Streetscape**)

Minimum House Size	Minimum Exposed House Frontage	Maximum Garage Width
36'	14'	22'
34'	12'	22'
32'	11'	21'
30'	10'	20'
28'	8'	20'
24'	10'	14'
22'	10'	12'

House Size & Pocket Fill (**RSL**)

Minimum House Size	Minimum Exposed House Frontage	Maximum Garage Width
32'	8'	24'
30'	8'	22'
28'	6'	22'
26'	6'	20'

**Note: Frontage calculations are based on home size not pocket width meaning that a 28' home with the noted calculations can be placed on a 30' pocket.*

The minimum house sizes are to be 1,600 sq. ft. for two storey homes and 1,200 sq. ft. for bungalow style homes.

This design guide allows for homes to be built in excess of the minimum requirements noted above. However, the minimums provide the opportunity for variations in size which, when combined with landscaping considerations, will contribute to the ultimate character of the neighbourhood.

Homes will be reviewed on their individual merits of design, massing, proportion, and compatibility and, where the Design Consultant considers the plan to be exceptional, and, provided that the house confirms with the general trend of the neighbourhood, exceptions may be considered.

6 Site Planning & Grading

Site planning and grading must accommodate the natural slope of the land with variations in grade absorbed within the building mass as much as possible. Lot grading must be in strict conformance with the approved grading plan for the subdivision. For lots with a more dramatic change in terrain such as walk-out basement lots or drive under lots, there may be a requirement for special terracing and/or retaining walls. The purchaser shall be responsible for the design and construction of such retaining structures and must ensure design grades and lot drainage are not compromised.

If a retaining wall is required it is to consist of concrete or natural materials such as boulders. If the retaining structure is to be more than 1 m (3'-0") in height, it must be stepped to reduce the wall's visual mass.

Special attention is to be given to the treatment of exposed concrete foundation walls. A maximum of 2' of parging will be permitted on all elevations of the homes. Variation in grade and basement design may require cladding material be lowered or extended to within 2' of ground level.

Front entry steps are to be a maximum of four risers per set. Where the grade requires more than four risers, the run must be split. Exceptions to this requirement may be granted in consideration of unique design, topography and lateral bracing concerns. If there are more than three risers per set, the step will be a minimum 4' wide with appropriate railing style. **For streetscape product only the garage side is permitted to have a setback of less than 1.05m.**

7 House Repetition

Similar or approximately identical house elevations must not be repeated within two lots (X-O-A-X) or directly across the street. To be considered different, an alternate elevation must reflect substantial modifications. Substantial modifications may include change in rooflines, house style, wall planes and materials. Repetitive use of elevations will be monitored to ensure an interesting and varied streetscape.

It is highly recommended that the same model not be placed adjacent to each other to meet this requirement.

8 Corner Lots

Houses on corner lots require special consideration. Flanking side elevations are to have suitable front elevation treatment with principle roof planes sloping toward view. All models will be considered for corner lots based on their unique suitability to these locations. Houses will require variation in wall planes, substantial roof line between floors, appropriate wall heights, window placement and detailing.

9 High Visibility Lots

High visibility rear elevations require special design consideration. These elevations must have openings of a number and size that is suited to the wall area, and incorporate detailing consistent with the front elevation and overall design. The lots affected will be those backing onto public spaces.

10 Garages & Driveways

Double attached garages as a maximum are allowed under the massing guides identified in Section 5 and must be located in accordance with the garage location plan. Triple car garages will not be permitted. The garage roofs are to correspond to the overall design/style of the home. Split design, side shed and rear shed will not be permitted.

Garage overhead doors must be compatible with the selected house style. The use of glass panels in overhead doors is required for all lots with front attached garages. The style of glass panels must be simple with no grills or transoms and applied in a vertical or horizontal design. Garage doors are to be a contemporary modern design with simple flat detail. Other modern design styles may be considered on a lot by lot basis. Sunburst or other glazing patterns and standard raised panel door styles will not be permitted.

Driveways and front walks are to be broom finished concrete at minimum, but may be exposed aggregate concrete, stamped concrete or broom finished concrete with stamped or exposed aggregate borders. Unit pavers are permitted as an accent or border material only. Driveway widths are not to exceed the width of the garage. Driveways should allow for all landscape requirements to be met.

A maximum of 18" must be maintained between overhead garage door and the eave line. Where the height exceeds 18", special detailing may be required. Gable ends will require appropriate detailing to soften the visual impact accordingly. Corners of overhead door must be straight. Angled corners will not be permitted.

11 Exterior Colours

Colours will be approved on an individual basis and are to reflect the colour palettes requirements that are indicated in Appendix "B" - Styles. Colours will not be duplicated within two lots or directly across the street. The use of a third accent colour is required. In keeping with the character of the neighbourhood and in consideration of blended streetscapes, pastel colours are not permitted.

All homes will require main wall colours to contain medium to dark earth tones. See Appendix "C" for approved colour selections.

Darker colour palettes are to dominate the streetscapes. Tonal colour schemes will also be permitted (ie. example dark grey siding with light grey trims). White trim colours will not be permitted on homes. Overhead doors are to match either the main or trim colour (white will not be permitted) but other colours will be considered on an individual basis. Accent bold front entry door colours are encouraged. Window frames and casements that match the exterior colour scheme are highly encouraged.

Very light, buff or white masonry colours are not permitted.

12 Roof Pitch & Materials

To provide a unifying theme throughout the subdivision, the roof pitch is to correspond to the style of home as indicated in Appendix "B" - Styles. All homes should contain a hip or cottage style roof design. Flat, gable or shed roofs are permitted as accent roof features if the roof design reflects the desired style of home as indicated in Appendix "B" - Styles. Bungalows will require a minimum of 7/12 pitch to enhance massing. In consideration of overall massing and style, some secondary roofs may not be subject to this minimum requirement. Flat roofs may be permitted as a secondary roof line on classic modern home styles and will be reviewed on an individual basis at the discretion of the Design Consultant.

For Streetscape models the primary eaves are strongly encouraged to be a minimum of 12" depth. The use of increased eave depth will be dependent on the overall design of home and will be at the discretion of the Design Consultant.

The roofing materials/colours may be selected from the following:

- Decra Shingle profile (Fawn Grey, Slate) Shake profile (compatible colours to be reviewed on an individual basis);
- IKO Cambridge 30 (Weatherwood, Driftwood, Charcoal Grey, Harvard Slate, Dual Black);
- BP Harmony 30 (Stonewood, Twilight Grey, Weathered Rock, Shadow Black);
- Elk Prestige 11 30/40/50 (Weatherwood, Antique Slate, Sablewood) Grand Series (Barkwood).

Roof overhangs will be proportionate to the design with suitable overhangs incorporated at all cantilevers, box-outs and bays. A minimum 8" fascia is required.

13 Front Entrances & Columns

Entranceways will be covered at a level that encloses and protects the space at the first level or a height proportionate to the design. Two storey pillared entries will not be permitted.

Front entry doors are to be a design compatible with the house style and to contain glazing or a sidelight in lieu of door glazing. Standard metal raised panel doors are not permitted. Fanlight or sunburst door glazing is not permitted. Sidelights are highly encouraged.

The following are examples of acceptable door styles:

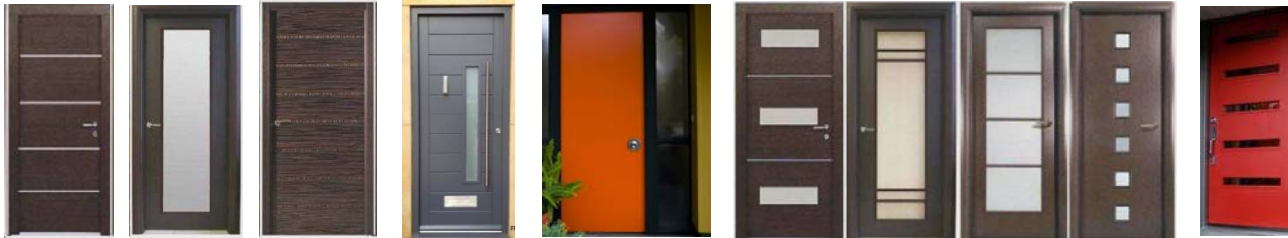

Front entry steps are to be a maximum of 4 risers per set. Where the grade requires more than four risers, the run must be split. Exceptions to this requirement may be granted in consideration of unique design or enhanced verandah treatment. Front stair risers are to be finished with a minimum of broom finish – wood or open stair treads will not be permitted. Verandas and porches must be skirted to grade with hardie panel, broom finish concrete or stone cladding – lattice is not an acceptable material. In situations where the height of the verandah or risers from final grade exceed 1m, then enhanced finishes such as exposed aggregate will be required in lieu of a typical broom finished concrete. Metal railings matching or tonal to the house colour are the minimum requirement on the verandah. Wood railings will not be permitted.

Where columns or posts are used on the front or highly visible elevations, they are to be of substantial form (min. 16" x 16") and solid in appearance. Column details are to be consistent with the selected style of the home. Typical vinyl siding material and metal cladding on columns is not acceptable. All columns are to be clad with a minimum of panel board or stone and are to match the trim colour of the home. Tiered or columns containing multiple materials are not permitted. Wood or wood – like siding (ie. Longboard or equivalent) material will be considered subject to design details.

All Streetscape homes are to contain a full width seating area with either a covered verandah or landscape patio with a wood or architectural screen – see Section 15.2 Landscape and Appendix “D” for landscape patio and screen requirements.

14 Exterior Finishes & Other Design Details

To achieve the standard and caliber of visual appeal, a requirement for architectural detailing and continuity will apply to all homes.

Brick or stone will be required in a panel or accent effect, reflecting the house style. A panel effect for example is if stone or brick is applied at the garage front, it must extend the height of the garage including above the overhead door. An alternate application of 75% of the wall height (height of garage door) will be allowed at the discretion of the Design Consultant. If masonry is applied on only one side of the garage door, then the column(s) will be required to be clad with masonry. River rock stone profiles will not be permitted. A reduction in masonry use will be considered by the Design Consultant if additional detail is applied for visual interest and is in accordance to the selected house style as well as the theme of the neighbourhood.

All homes are to be finished in either Acrylic Stucco, Hardie Plank or Premium Vinyl Siding and must reflect the house style as indicated in Appendix “B” Styles. All homes are to have contain one (1) secondary wall material in addition to masonry. The use of shakes is strictly prohibited on homes. The removal of the requirement of the secondary wall material will depend on the overall style of the home, and is at the discretion of the Design Consultant. Please refer to Appendix “B” Styles.

Acceptable cladding materials include:

- Hardie Plank (James Hardie);
- stucco in sand float or smooth finish;
- special “wood” accent material such as Sagiwall or Longboard siding applied in a “block panel” feature suited to design;
- Hardie and metal panel may be used if suited to design;
- Premium vinyl siding products (traditional lap or bevel profile).

The use of brackets and louvres may be permitted if it meets the selected house style as depicted in Appendix “B” Styles. The use of shutters will not be permitted.

All trim details, secondary wall materials and masonry must be returned to the adjacent wall. If the distance between wall planes does exceed 5'-0", a 2'-0" return will be sufficient. The use of stucco as trim is only permitted on homes that are primarily finished in stucco.

The use of window and door surrounds will be a feature on all homes. Trims are to be a minimum of 4" – 6". Trims are to be applied consistent with the selected house style. The reduction of trim size or omission of window and door surrounds will be subject to the overall design of the home.

Windows are to be large, organized, consistent in shape and contemporary in design. Window style and grill pattern are to be consistent with the selected house style. **Curved or circular style windows and traditional style windows with mullions or grills will not be permitted.** Window frames and casements are highly encouraged to reflect the colour scheme of the home. Brickmold window trims will not be permitted in lieu of window surrounds unless approved by the Designated Design Consultant.

Homes will be reviewed on their individual merits of design, massing proportion and compatibility and, where the Design Consultant considers the plan to be exceptional, and, provided that the house conforms to the general trend of the neighbourhood, exceptions may be considered.

15 Fencing + Landscape + Other

15.1 Fencing

Fencing on all lots are to be constructed by the Homeowner and shall be consistent in design and colour with the fencing style established for the community. All wood screen fences are to be painted Mushroom Fields by Cloverdale Paints (Weather One Designer Selections Colour Code EX216). Typical wood screen fence will be a standard requirement however for all park backing lots (Block 3, Lot 8-23) where the Developer has provided a rear chain link fence it will be, the responsibility of the Homeowner to install a step down wood screen fence that extends 16' up the side yard connecting to the Developer's fence. Chain link side yard fences will only be permitted and required on all lots that back onto a pond. See Appendix "E" for fence details.

15.2 Landscape

It is the responsibility of the homeowner to landscape the yard. In the case of corner lots, the front yard shall include the flanking side yard to the sidewalk, curb or boulevard and to the rear corner of the house.

The minimum landscape standard for all lots shall be as follows:

Pocket Width	# Deciduous Trees	# Coniferous Trees	# Shrubs
24'	1	1	10
26' - 36'	2	1	10

At least one tree must be planted in the front yard. A maximum of 50% sod shall be used in the front yard. All lots shall have a prepared shrub bed in the front yard containing at least 10 shrubs. Shrubs shall be 18" in height or spread. The application of artificial turf or landscapes without sod will only be considered by the Developer by way of submission of a detailed landscape concept drawing prepared by a Landscape Architect.

A prepared bed is to be defined by landscape edging (metal, vinyl, brick, concrete, etc.) with adequate coverage of plant material and is to contain mulch (rock, wood chip, etc.) for ground cover. In scenarios where the minimum plant material is unable to provide adequate coverage, additional plant material such as ornamental grasses, perennials or additional shrubs are to be placed throughout the bed to break up large areas of mulch (rock or wood). Large areas of rock or wood mulch will not be permitted in the front yard and highly visible rear yards. The minimum deciduous tree shall be 2.5" caliper - measured 6" above ground. Coniferous trees (spruce or pine) must be a minimum 8' (2 m) height.

The rear yard of all lots will require a minimum of sod. In addition all lots backing onto or have side yards flanking 182nd Street, parks, schools, walkways and ponds will require a minimum of 3 trees or 2 trees and 10 shrubs in the rear yard.

If artificial turf is desired, it is to be designed with a distinct prepared shrub bed border between the turf and the property line. The shrub bed is to include adequate coverage of plant material that is in addition to the above minimum requirements. Artificial turf is to contain a minimum weight of no less than 95 ounces per square yard and a minimum blade height of 41mm (ie. ezLAWN, ezLAWN

Elite, ezLAN Platinum) are acceptable. The base is to contain a minimum depth of 4" of 20mm road crush (compacted to 90% proctor density) with a sand or crushed limestone (fine) topping. The surface infill is to contain either a Silica sand and/or rubber infill. All artificial turf must be specified by the manufacturer as a pet friendly product with a minimum 10 year warranty. Homeowners will be required to submit their artificial turf invoice prior to final inspection to verify that the specifications have been met.

All lots are to meet City of Edmonton Zoning Bylaw Landscape requirements and it is the responsibility of the homeowner to ensure that their landscaping meets these requirements.

All landscaping including front, rear, sides and fencing must be completed, in accordance with the requirements, within twelve months of completion of the house (subject to seasonal limitations). To ensure compliance with the landscaping requirements, a \$2,500.00 security deposit must be paid by the Purchaser, to be refunded by the Builder, upon confirmation of the satisfactory completion of the landscaping.

***Please Note: All Streetscape homes are to contain a full width seating area with either a covered verandah or landscape patio with a wood or architectural screen.**

- **Where a substantial verandah is being provided (No more than 8' back from the front garage wall plane) a landscape patio with wood screen is not required.**
- **With no verandah, or a verandah back from the front garage wall plane more than 8', a landscape patio and screen must be provided.**
- **Where a landscape patio and wood/architectural screen are required, patio and screen plans must be submitted with house plan for approval, and must be constructed in accordance with approved plans. Patios and screens not constructed as approved will result in deficient landscape inspections.**

See Appendix "D" for landscape patio and screen requirements.

15.3 Address Plaque

A standardized address plaque, as per the detail provided by the Developer, is required for all homes. Address plaques must be ordered through Rohit Land Development and to be installed by the Builder. It shall be placed on the front of the garage in a visible location and is highly recommended that the builder show location of the Address Plaque on house approval applications. Alternate locations may be accepted at the discretion of the Design Consultant. See Appendix "F" Address Plaque for address plaque mounting instructions.

15.4 Accessory Buildings

The side wall elevations of all ancillary buildings and garden sheds shall not extend more than 6'. Where visible from a public adjacency (i.e. all perimeter lots and corner lots), accessory buildings must be consistent in style, finish and colour, with the house. Roof style and materials are to match the materials used on the roof of the house.

Sheds completed in an alternative plastic composite material will also be permitted in earth toned colours. Sheds containing unfinished wood are strictly prohibited. Metal sheds are strictly prohibited.

The following shed styles are acceptable, provided they are complementary to the style of the home:



The following are examples of sheds that will NOT be accepted:



15.5 Interpretation

The enforcement, administration and interpretation of this design guide shall be at the discretion of Rohit Land at Arbours of Keswick Ltd. or its Designated Design Consultant. The unfettered application of these guidelines shall be without notice or precedent.

16 Siting

16.1 Consultant

The Builder is to check on archcontrol.com and the Developer for all applicable drawings, and any special conditions.

16.2 City Regulations

The Builder is to ensure that all City of Edmonton bylaws and regulations are met and note relevant plans regarding utilities and rights-of-way.

16.3 Grading

The Builder is to check Building Grade Plans and conform to them. Do not grade to existing vacant lots or unfinished lanes, but to elevations provided.

16.4 Plot Plans

The preparation of plot plans and stakeout must be carried out by the Designated Surveyor only. Plot plans must include:

- scale 1:300 metric with north arrow and municipal address;
- legal description of property;
- all property lines, designated and dimensioned;
- size and location of proposed building(s) dimensioned to property lines, existing building and other structure where applicable;
- all cantilevers (including floor, bay windows, fireplaces, eaves, etc.);
- abutting streets, avenues, reserves, easements and utility right-of-ways labeled, dimensioned;
- spot elevations around building and drainage directions;
- dimensions from property line to sidewalk and face of curbs.

17 Subdivision Appearance

17.1 Signage

In order to maintain cohesiveness for signage within the subdivision, all signage will be supplied by the Developer, i.e. all model signs, directional signs and general information signs. All Builder signage must be approved by the Developer.

17.2 Excavation Material

All Builders must ensure that all excavation is kept within the confines of their lot. Any spillage on a road, land, sidewalk or neighbouring lot must be removed immediately or the Developer will arrange for its removal and invoice for expenses. There is absolutely no onsite disposal.

17.3 Clean-Up

Builders should encourage timely removal by all sub-trades of litter on building sites. Failure to comply will result in a clean-up bill being charged to the lot. Supply of bins by the Builder is recommended. Any general clean-up of the subdivision implemented by the Developer can and will be charged pro-rata to all Builders.

17.4 Construction Activity

Each Builder is responsible for inspecting the condition of curbs, sidewalks, street lights, services, etc. on his lot and must submit written notice of any damages to the Developer prior to commencing construction, otherwise costs for repairing any damages becomes the sole responsibility of the Builder.

18 Approval Process

Prior to building, the Builder inspects the lot and all services. All discrepancies or damage are to be reported in writing with the application and a copy forwarded to the Developer.

Before applying to the City for a development permit, the applicant shall submit plans for approval to the Design Consultant via the Archcontrol.com website. The plans shall include elevations, plans, cross sections, roof plans and other information. The proposed architectural theme of the home is to be stated (i.e. Prairie Modern, Classic Modern, etc.). The plan will be reviewed and recommend approval, modification, or rejection of the application based on the adherence of the plans to these guides.

Should disputes arise, the Developer shall make the final decision on the acceptability of plans. After approval, the plans may not be altered without prior approval.

Approval of any and all house plans will be at the sole and unfettered discretion of the Vendor.

Variation to these Guidelines will be at the sole discretion of the Designated Design Consultant.

No stakeout will be granted until design approval. All approvals will be posted on archcontrol.com.

Appendix “A” – Community Map

PARK & FUTURE SCHOOL SITE

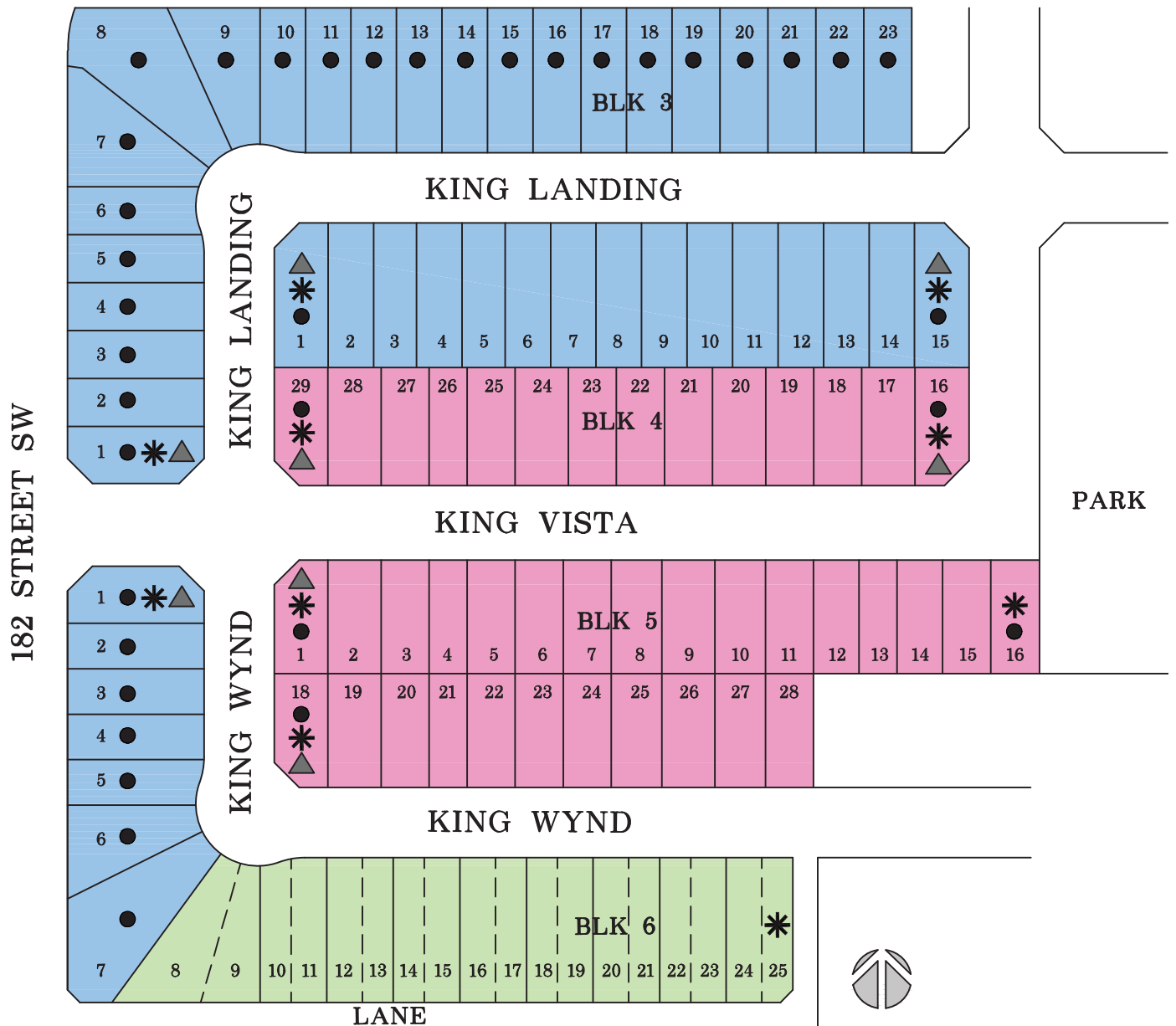

Legend

- SINGLE FAMILY RESIDENTIAL - RSL
- STREETSCAPE SINGLE FAMILY LOT
- SEMI-DETACHED LOT
- ENHANCED REAR ELEVATION
- * ENHANCED SIDE ELEVATION
- ▲ 2.5m WIDE SIDE YARD



Stage 1A
Design Guidelines

September 07, 2017



Appendix “B” – Styles

Classic Modern

DESIGN STATEMENT

The Modern classic style allows for unique non-traditional forms with heavy emphasize on modern detailing. Key design features that defines this style:

- Inward facing shed roof;
- Wood or metal panel detailing;
- Simple/modern details;
- Masonry applied as panel detail;
- Mix of vertical and horizontal oriented windows;
- Pergola (wood or metal) front entrance;
- Bold coloured doors;
- Flat garage door with vertical glazing.

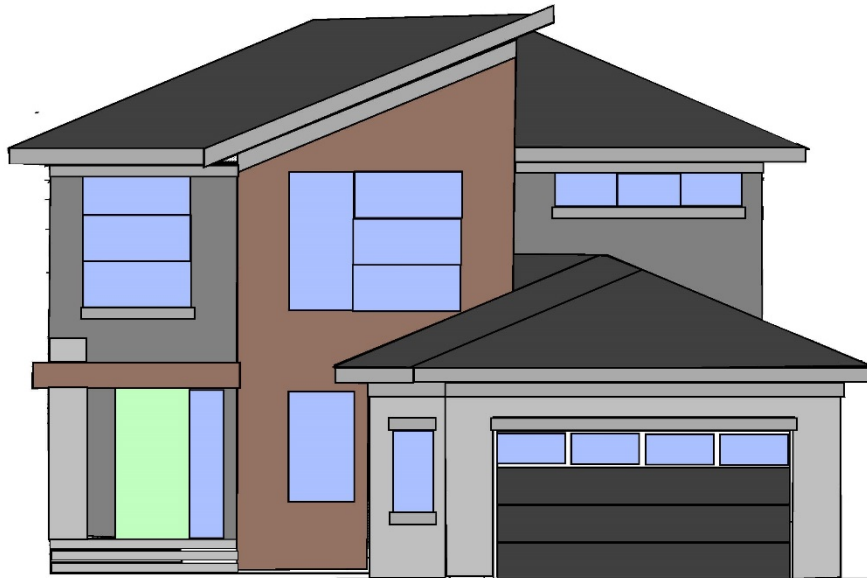

OVERALL BUILDING MASSING

Homes are to be designed to represent a simple massing design. Roof slopes are to be 3/12 to 5/12 with 1'-6" roof overhangs. However, 2' overhangs are highly encouraged.

ROOF STYLES

Modern classic homes will require a hip style roof with a combination of either a flat or shed roof. A single shed roof is highly encouraged. Shed roof lines are to face inwards to minimize exposed wall height on side elevations. Side shed or rear shed rooflines on the garage will not be permitted. Flat roofs over the garage in conjunction with a balcony would be acceptable.

DEFINING DETAILS

Homes are defined with modern features that include metal or wood panel with large thick windows that extend into the shed roof. A horizontal accent wall or "fin" wall may be introduced.

EXTERIOR CLADDING

May be finished in horizontal siding, Hardie plank siding, brick/stone or smooth stucco.

STONE OR BRICK PROFILES

Stone and brick are applied in a panel effect or as a substantial accent. When applied as an accent the top edge is finished with a soldier course or heavy step trim.

COLOURS

Colours suited for the modern classic include mid to deep earth tones accented by tonal or low contrasting trims.

ENTRANCE TREATMENT

Flat roof, pergolas or shed roofs are a common feature for verandah. Entry doors are simple and bold with usually with frosted glazing.

Prairie Modern

DESIGN STATEMENT

The Prairie style allows for simplified, horizontal forms with some modern details. Key design features that defines this style:

- No gables;
- Simple/modern details;
- Masonry applied as panel;
- Horizontal oriented windows;
- Horizontal panel and trim banding;
- Thick 6" trims;
- Stone columns;
- Flat panel door with sidelights.

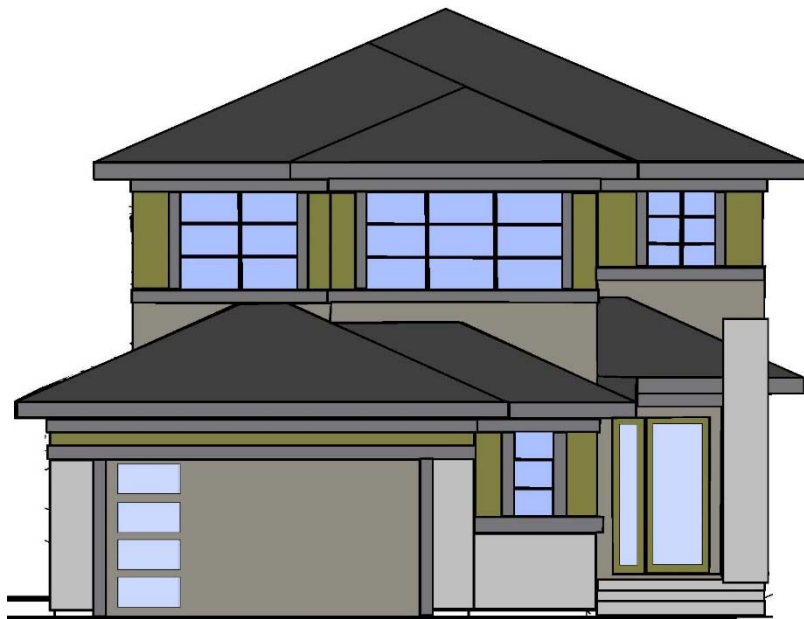

OVERALL BUILDING MASSING

The footprint is often L shaped. Roof slopes are to be low, 4/12-5/12 with wide overhangs – generally 18" – 24" deep soffits.

ROOF STYLES

Characterized by a simple hip or cottage style roof. A flat roof may be introduced on a verandah for the front entryway.

DEFINING DETAILS

Homes are to be designed to reflect a horizontal presentation. Horizontal band below the soffits and thick top and bottom trims on windows are typical details. A horizontal accent wall or "fin" wall may be introduced.

STONE OR BRICK PROFILES

Brick is the most desired material for this style however stone is acceptable to use. Masonry is to be applied in panel effect. Brick is smooth, often applied with a rock face soldier course to emphasize the horizontal.

EXTERIOR CLADDING

To be finished in Horizontal siding or Hardie plank siding coordinated with Hardie panel applied to emphasize the horizontal presentation. Smooth stucco or flat brick outlined with wood trim will also be permitted.

COLOURS

Colours suited to the Prairie style are mid to dark earth tones with tonal trims.

ENTRANCE TREATMENT

The entry is typically defined by a flat panel door with recessed side lights. Flat roof, pergolas or cottage roofs are a common feature for the verandah. Columns are typically clad in stone with thick top and bottom trims.

Heritage Modern

DESIGN STATEMENT

The Heritage Moderns style allows for traditional forms with a modern interpretation of detailing. Key design features that defines this style:

- Maximum of 2 gables;
- Simple/modern details;
- Masonry applied as panel;
- Vertical oriented windows;
- Shed or Hip style verandah roof;
- Vertical siding or vinyl board and batten are common secondary wall materials;
- Front door contains glazing with modern grill designs.



OVERALL BUILDING MASSING

All model types are included with an emphasis on grounded proportions where the eye is drawn to the street level. Roof slopes are to be low at 5/12. Roof overhangs are minimum 1'6" at moderate pitch.

ROOF STYLES

A single gable will be required on the second floor and can consist of a 6/12 roof slope if it does not exceed half of the house width. If the gable does exceed half of the width of the home a max 5/12 roof slope is required. A gable encompassing the full house width will not be permitted. A second gable may be considered depending on the overall style of the home.

DEFINING DETAILS

A combination of strong modern features and simple detailing defines the heritage modern style which may include structural brackets or ganged vertical windows.

STONE OR BRICK PROFILES

Stone and brick are applied in a panel effect or as a substantial accent. When applied as an accent, the top edge is finished with a soldier course or heavy step trim.

EXTERIOR CLADDING

Vertical siding, panel board with trims, vinyl board and batten, brick/stone are common secondary wall materials used for this style of home.

COLOURS

Colours suited to the Heritage style include deep earth tones accented by contrasting heavy trims. White and light cladding colours are not suitable.

ENTRANCE TREATMENT

The entry are to be enclosed with verandahs consisting of a pergolas, hip or shed roofs. Entry doors are simple and often include a square glass pane with modern grilled designs.

Appendix “C” – Approved Colour Selections

Approved Colour Selections

The following are the approved Hardie Plank colours (by James Hardie) and Premium Siding (Mitten, Royal, Gentek, Kaycan) and are to be used as a basis for Acrylic Stucco colours.

Hardie Plank (by James Hardie)

- Khaki Brown
- Woodstock Brown
- Monterey Taupe
- Timberbark
- Rich Espresso
- Mountain Sage
- Chestnut Brown
- Iron Grey
- Aged Pewter
- Deep Ocean
- Evening Blue
- Grey Slate
- Night Grey

Premium Siding

Royal:

- Walnut
- Natural Cedar
- Granite
- Shamrock
- Ironstone
- Cocoa
- Midnight Surf
- Wedgewood
- Weathered Grey
- Marine Blue
- Bark
- Toasted Almond
- Storm

Mitten:

- Khaki Brown
- Rockaway Grey
- Muskoka Green
- Grenadier Green
- Aviator Green
- Caribou Brown
- Chestnut Brown
- Danish Gold
- Spring Moss
- Regatta Blue
- Sapphire Blue
- Annapolis Blue
- Timber Bark
- Gunmetal Grey
- Eggplant
- Coffee Brown

Gentek:

- Dark Drift
- Saddle Brown
- Moonlit Moss
- Windswept Smoke
- Midnight Surf
- Espresso
- Iron Ore
- Mountain Arbor

Kaycan:

- Mahogany
- Pecan
- Castlemore
- Cabot Brown
- Manor
- Evergreen

Blue and purple (eggplant) tones will be carefully reviewed and monitored to ensure compatibility with the design style and other homes.

Appendix “D” – Landscape Patio and Screen Requirements

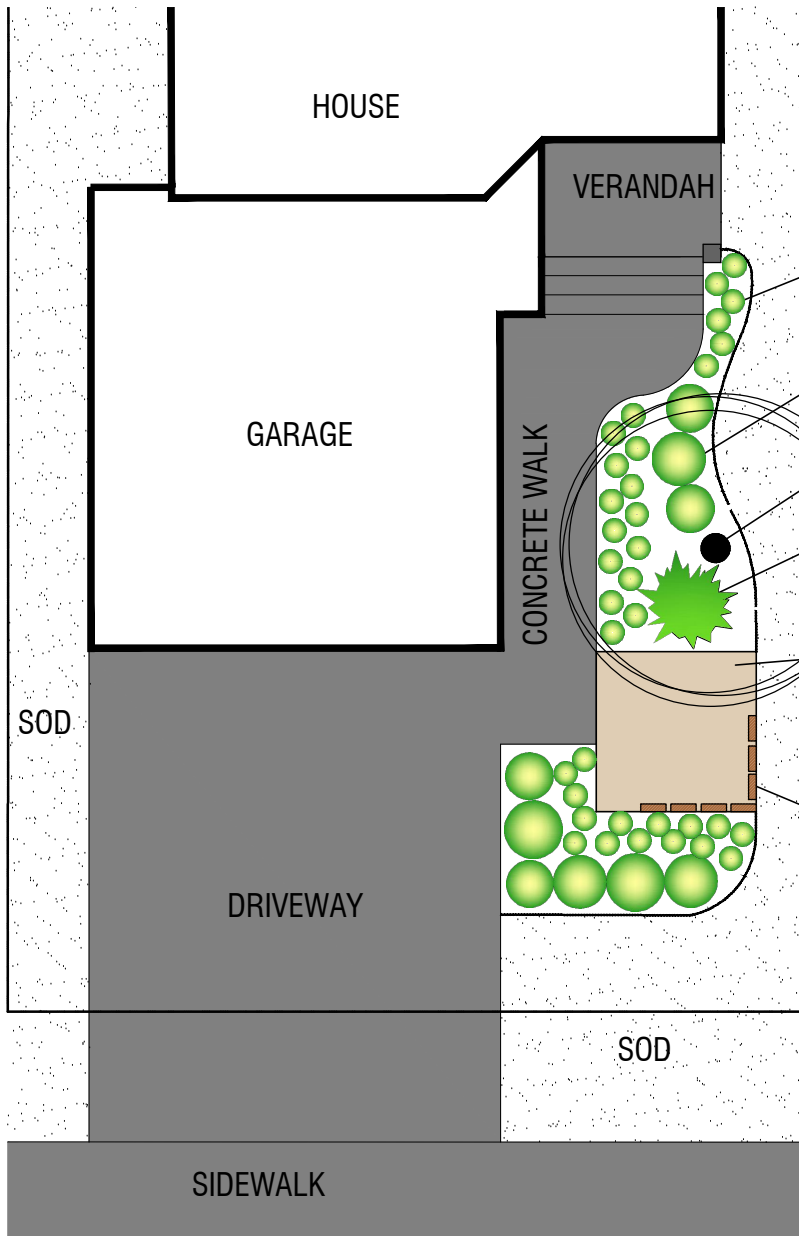

Landscape Patio and Screen Requirements:

-Where a substantial verandah is being provided (no more than 8' back from the front garage wall plane) a landscape patio with wood/architectural screen is not required.

-With no verandah, or a verandah back from the front garage wall plane more than 8', a landscape patio and screen must be provided.

-Where a landscape patio and wood/architectural screen are required, patio and screen plans **must be submitted with house plan for approval, and must be constructed in accordance with approved plans. Patios and screens not constructed as approved will result in deficient landscape inspections.**

NO CONCRETE / CONCRETE PATIO BLOCKS PERMITTED.
ACCEPTABLE ALTERNATIVE MATERIALS INCLUDE :
PAVERS, ORGANIC SHAPED STONE OR ROCK MULCH ETC.



WOOD OR ARCHITECTURAL SCREEN (MIN. 1.0m HEIGHT X 2.0m LENGTH)



LANDSCAPE PATIO AND SCREEN REQUIREMENTS

Appendix “E” – Fence Details

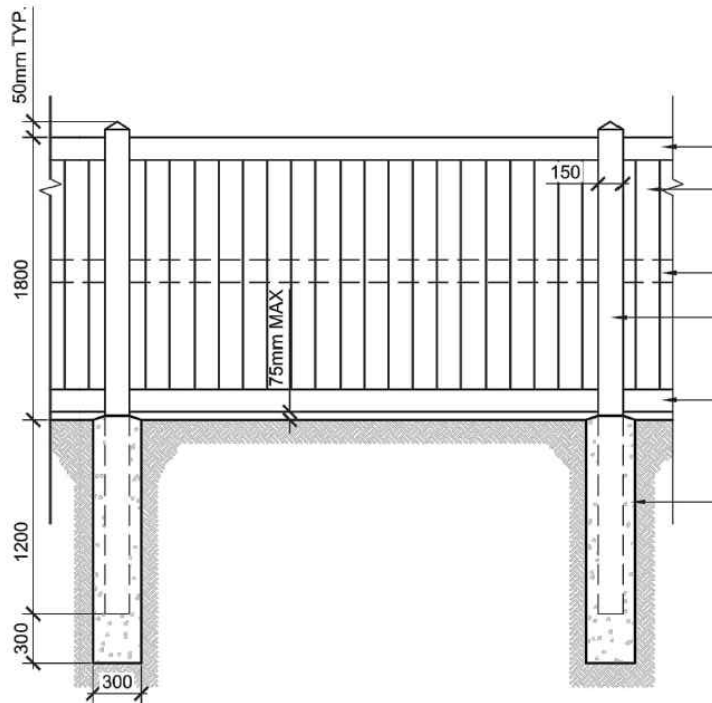
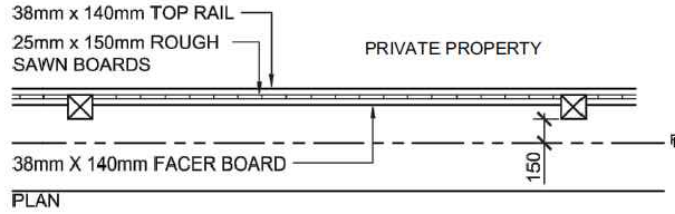

NOTES:

- FENCES INCLUDING THE CONCRETE PILE MUST BE CONSTRUCTED WHOLLY WITHIN PRIVATE PROPERTY.
- FENCES ON PRIVATE PROPERTY SHALL REQUIRE A MINIMUM OF PRESSURE TREATED POSTS AND BOTTOM RAILS. FENCES ON CITY PROPERTY SHALL REQUIRE ALL WOOD MEMBERS TO BE PRESSURE TREATED OR APPROVED EQUAL. ALL WOOD MEMBERS ABOVE GROUND TO BE NON-INCISED.
- ALL NAILS TO BE 60mm SPIRAL GALVANIZED. USE AS REQUIRED TO ENSURE SECURE ASSEMBLY.
- WOOD USED MAY BE LODGEPOLE PINE, FIR, HEMLOCK OR SPRUCE, DEPENDANT ON AVAILABILITY AT TIME OF CONSTRUCTION.
- ALL STAIN TO BE AS PER LANDSCAPE ARCHITECT. APPLY 2 COATS AS PER MANUFACTURERS SPECIFICATIONS. COLOUR TO BE DETERMINED BY LANDSCAPE ARCHITECT. STAIN BOARDS ALL FOUR SIDES PRIOR TO CONSTRUCTION.
- PRESSURE TREATED POSTS TO BE TREATED WITH A SOLUTION OF PENTACHLOROPHENOL AND PETROLEUM TO CSA-080.
- PROPERTY LINE OFFSET DIRECTION VARIES. REFER TO PLAN.
- ALL DIMENSIONS IN MILLIMETERS.

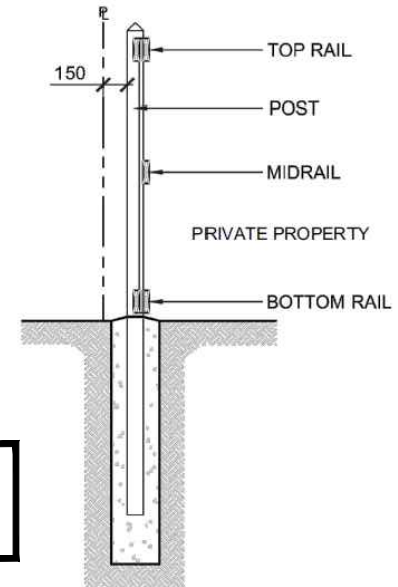

COLOUR:
Mushroom Fields - PAINT BY CLOVERDALE PAINTS
(Weather One Designer Selections Colour Code EX216)



TYPICAL WOOD SCREEN FENCE DETAIL

SCALE: NTS

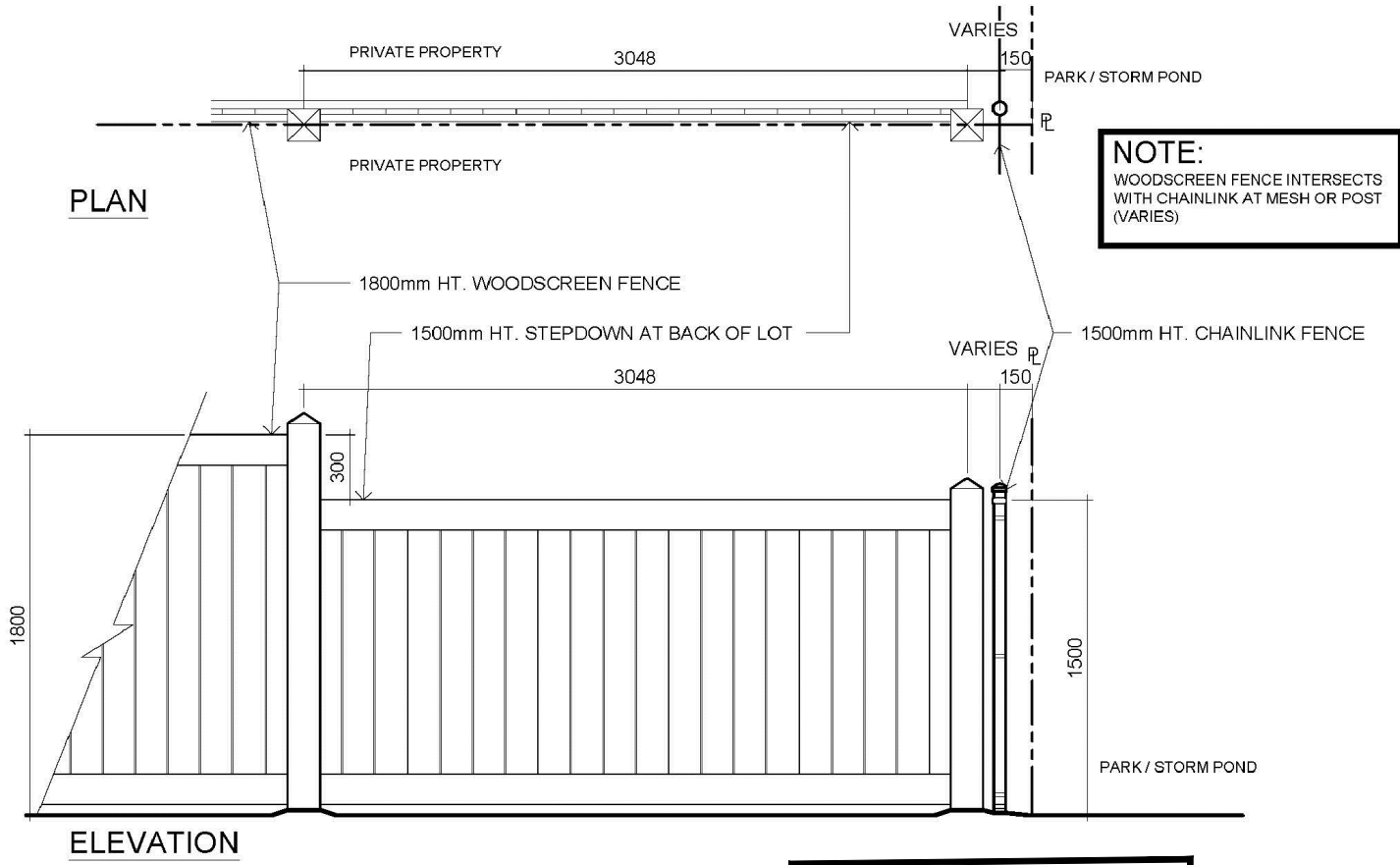

ARBOURS
OF KESWICK

STEPDOWN WOOD SCREEN FENCE DETAIL

SCALE: NTS

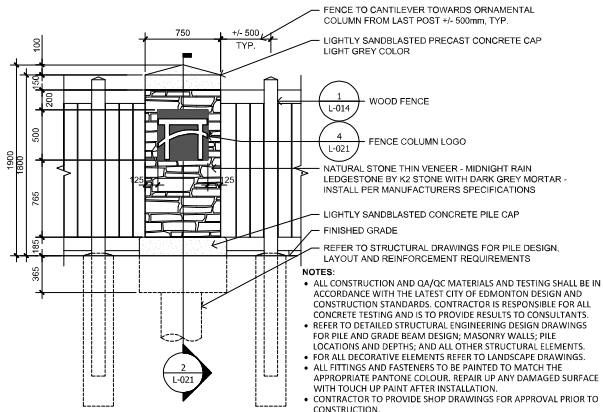

1 FENCE COLUMN ELEVATION TYPE - A (WITH LOGO)
 SCALE: 1:25

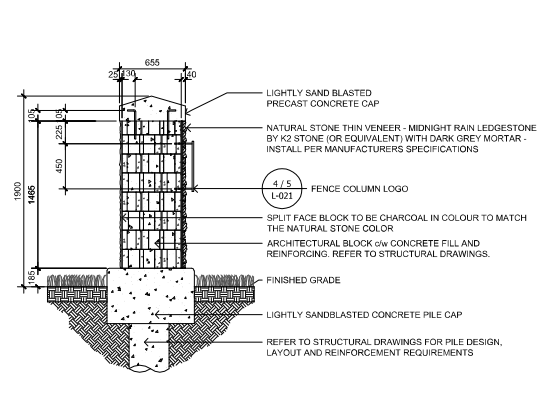

2 FENCE COLUMN SECTION TYPE - A (WITH LOGO)
 SCALE: 1:25

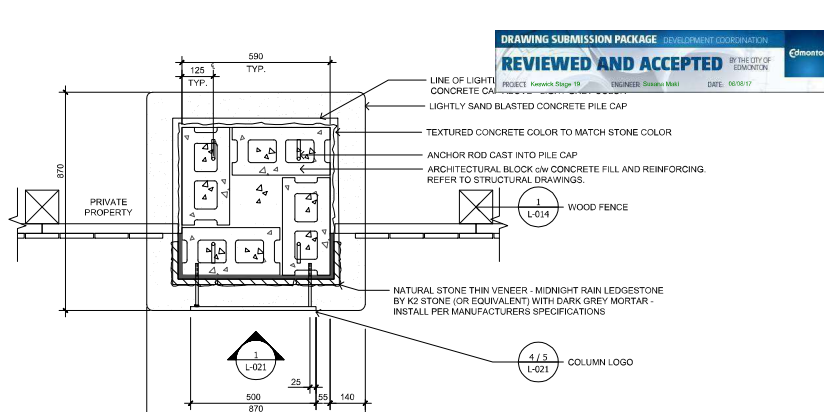

3 TYPICAL COLUMN CROSS SECTION TYPE - A (WITH LOGO)
 SCALE: 1:10

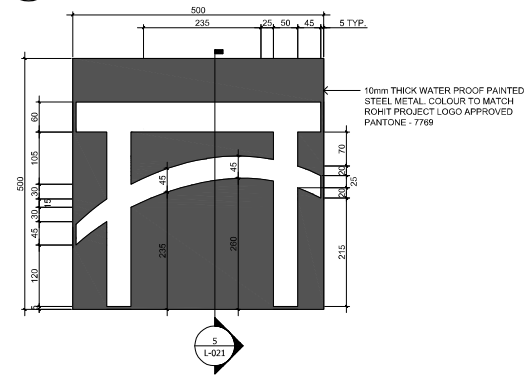

4 COLUMN LOGO ELEVATION
 SCALE: 1:5

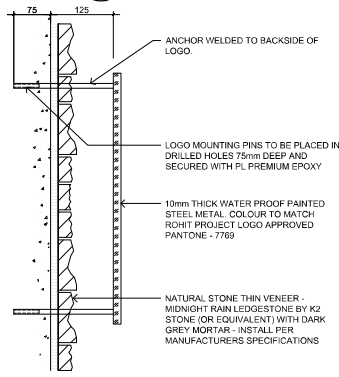

5 COLUMN LOGO SECTION
 SCALE: 1:5

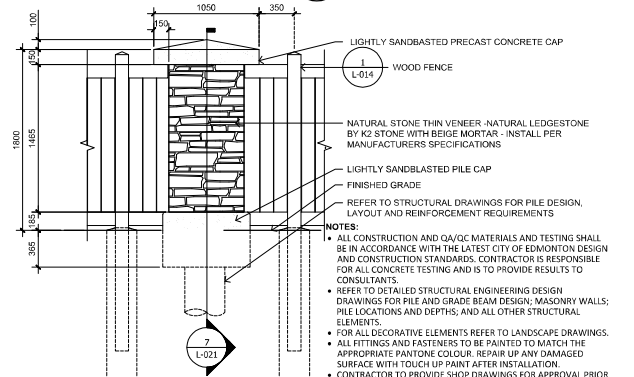

6 FENCE COLUMN ELEVATION TYPE - B
 SCALE: 1:25

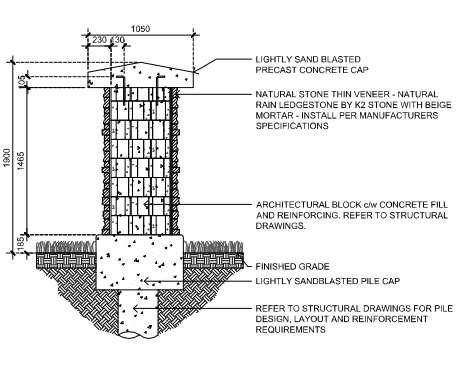

7 FENCE COLUMN SECTION TYPE - B
 SCALE: 1:25

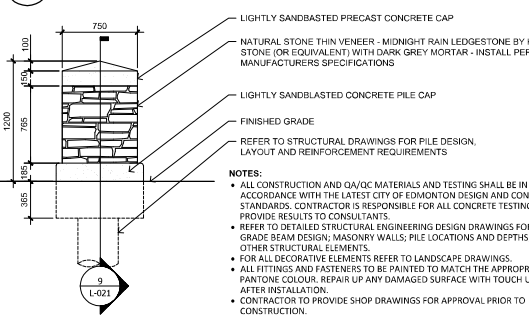

8 FENCE COLUMN ELEVATION TYPE - C
 SCALE: 1:25

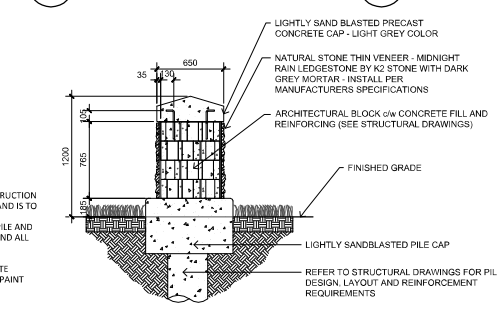

9 FENCE COLUMN SECTION TYPE - C
 SCALE: 1:25

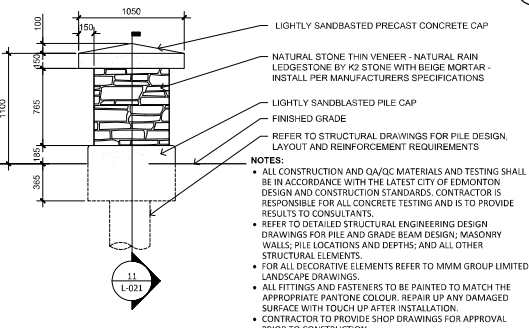

10 FENCE COLUMN ELEVATION TYPE - D
 SCALE: 1:25

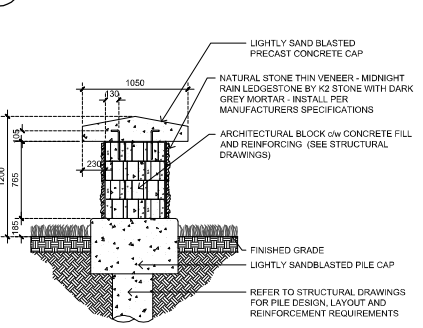

11 FENCE COLUMN SECTION TYPE - D
 SCALE: 1:25

ISSUE DATES		BY		NO.		DATE		REVISIONS		APPROVED BY:	
DATE	DESCRIPTION	T.T.	T.T.	A	B	C		DESCRIPTION		T.T.	
16/12/20	PRELIMINARY	T.T.	T.T.	A				REVISED AS PER CITY COMMENTS		T.T.	
17/05/12	FOR APPROVAL	T.T.	T.T.	B				REVISED AS PER CITY COMMENTS		T.T.	
	FOR TENDER	T.T.	T.T.	C				REVISED AS PER CITY COMMENTS		T.T.	
17/06/05	FOR CONSTRUCTION	T.T.	T.T.								
	AS-BUILT										

CONSTRUCTION RECORD		CITY OF EDMONTON APPROVED	
STARTED	COMPLETED		

SCALE:	
DESIGNED BY: C.C.	DATE: 11/2015
DRAWN BY: C.V.	DATE: 11/2016
CHECKED BY: J.G.	DATE: 12/2016
APPROVED BY: T.T.	DATE: 12/2016
PERMITS/APPROVALS	
	DATE

CITY OF EDMONTON		KESWICK STAGE 19 & SWMF	
RIVERVIEW AT WINDERMERE LTD.		ORNAMENTAL COLUMNS DETAILS	
		PROJECT NO. 5311024000	REVISION C
		DRAWING NO. L001-021	SHEET 21

Masonry Column Detail applies only to lots that back onto 182 Street.

Appendix “F” – Address Plaque

Keswick Address Plaque Installation Guide

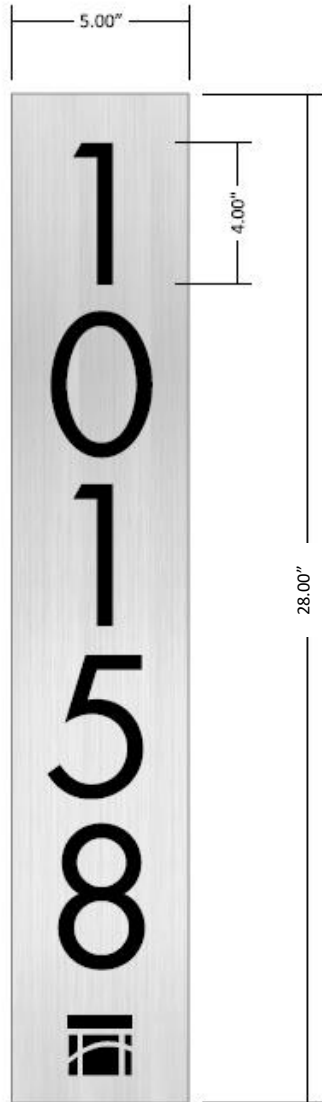

1. Layout location of address plaque as per house plan approval
2. Hold plaque drill template firmly against the exterior wall as per the measured location
3. With the template firmly in place mark the hole locations.
4. Using a 1/4" drill, drill the marked locations 1/8" to a 1/4" deeper than the 3/16" pin on the back of the address plaque
5. Clean all debris out of the holes.
6. Dry fit the address plaque to ensure the plaque sits flat and even on the exterior wall and that the alignment is level
7. Fill the drilled holes with a two part epoxy and install the address plaque. Do not over fill the holes beyond the exterior wall surface as excess epoxy will squeeze out beyond the address plaque
8. Secure the plaque in place using tape that will not damage or mark the exterior wall
9. Allow epoxy to cure for 12 hours before removing the tape carefully. Read epoxy information regarding cure times based on temperature during cold weather conditions

Note: Each Builder in the Subdivision will be provided with two (2) drilling templates. Additional drilling templates can be purchased from Rohit for \$20.00 each.

All Homes in the subdivision require a standardized address plaque. It shall be placed on the front of the home in a highly visible location, to be approved at the discretion of the architectural consultant. It is recommended that builders show the location of address plaques on house plan approval submissions.